

TOP VIEW

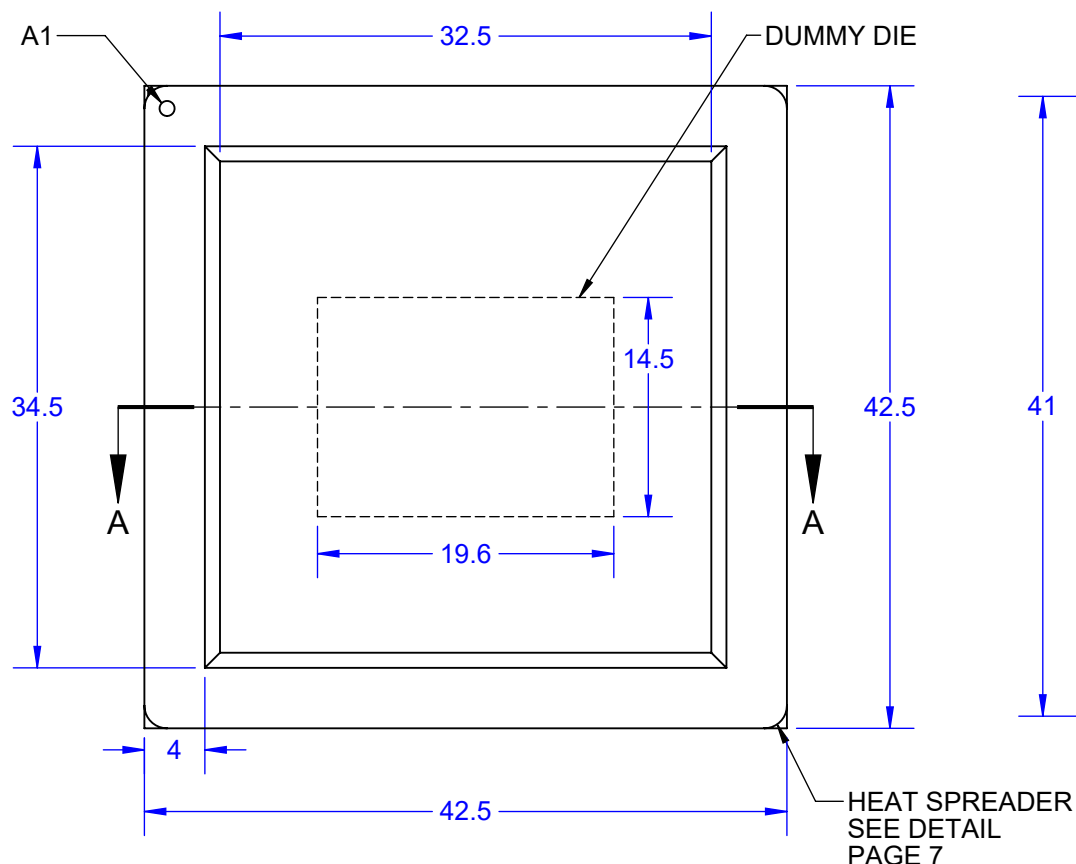

BALL VIEW

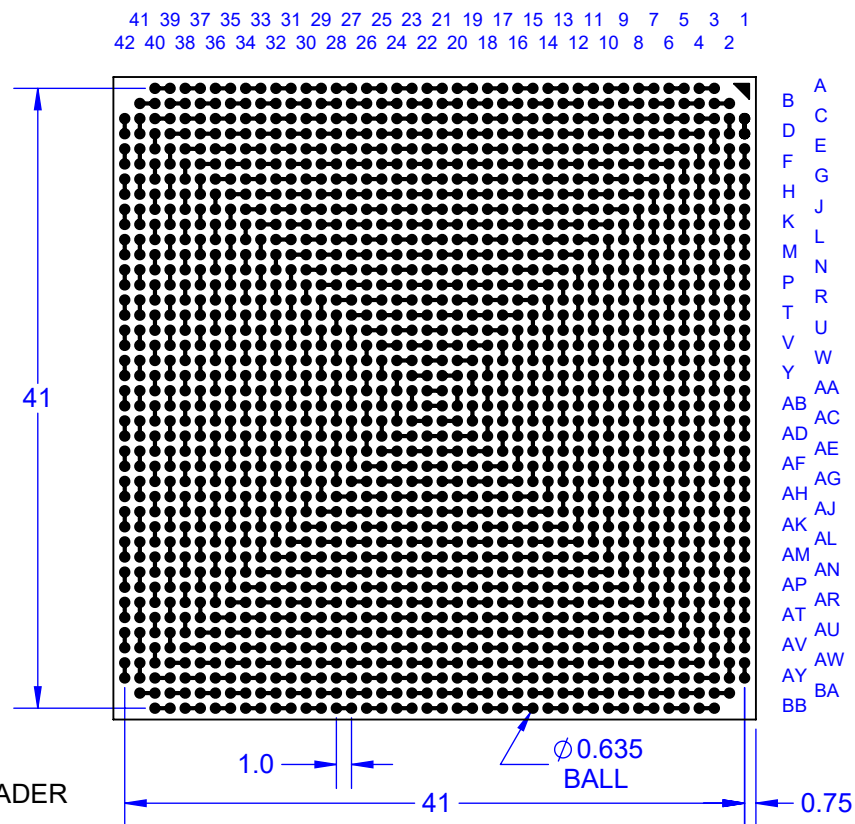

Notes: (Unless Otherwise Specified).

- 1) ALL DIMENSIONS ARE IN MM.
- 2) SOLDER BALL ALLOY: SEE PART NUMBER TABLE.
- 3) BALL DIAMETER (BEFORE REFLOW) 0.635mm [25mil].
- 4) SOLDER MASK DEFINED PAD OPENING: 0.508mm [20mil].
- 5) PAD Cu DIAMETER: 0.635 [0.25 mil].
- 6) SUBSTRATE MATERIAL: FR4.
- 7) DUMMY DIE: Si (SILICON).
- 8) DAISY CHAIN PATTERN (SEE PAGE 2).
- 9) MSL-3 RECOMMENDED BAKING 24 HOURS @ 125°C TO REMOVE MOISTURE PRIOR TO SOLDERING TO PC BOARD.

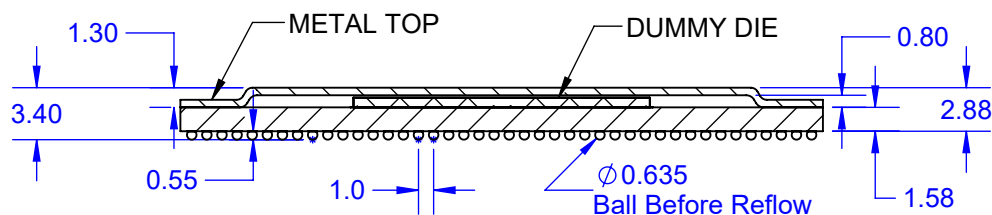

SECTION A-A

PART NUMBER TABLE

PART NUMBER	BALL METAL	BALL ALLOY	RoHS	Si DIE
SBGA1752T1.0C-DC427D	Sn96.5/Ag3.0/Cu0.5	SAC305	YES	YES
SBGA1752T1.0-DC427D	Sn63/Pb37	Sn63	NO	YES

APPROVALS	DATE	TopLine®			
DRAWN T. Au	05/13/16				
ENG M. Hart	05/13/16	TITLE SBGA1752T1.0C-DC427D DAISY CHAIN DUMMY			
MFG		SCALE	SIZE	DRAWING NO.	REV
QA		2:1	A	514275	A
CUST		DO NOT SCALE DRAWING			SHEET 1 OF 18
REVISED					

BALL VIEW

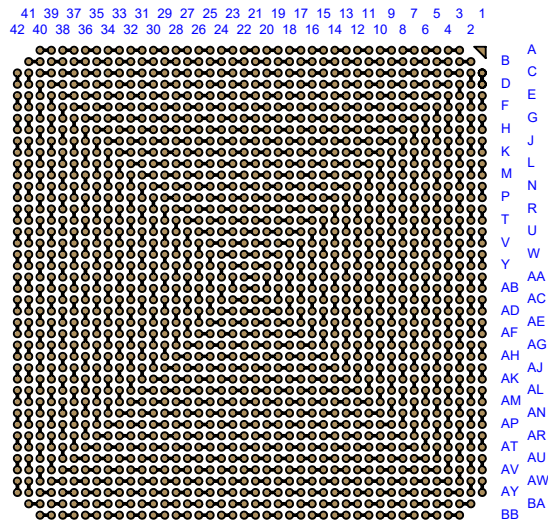

BOTTOM SIDE (TOP X-RAY VIEW)

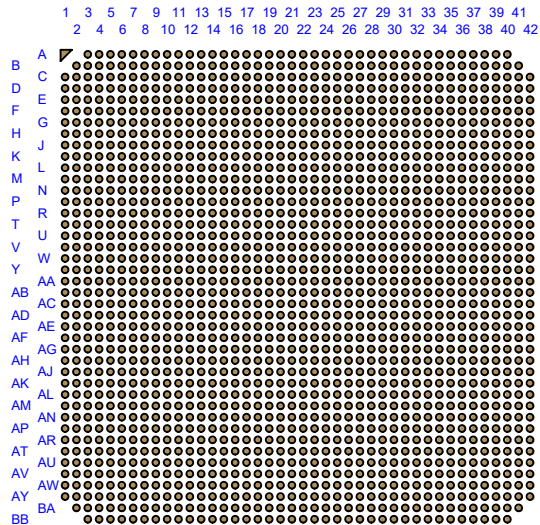
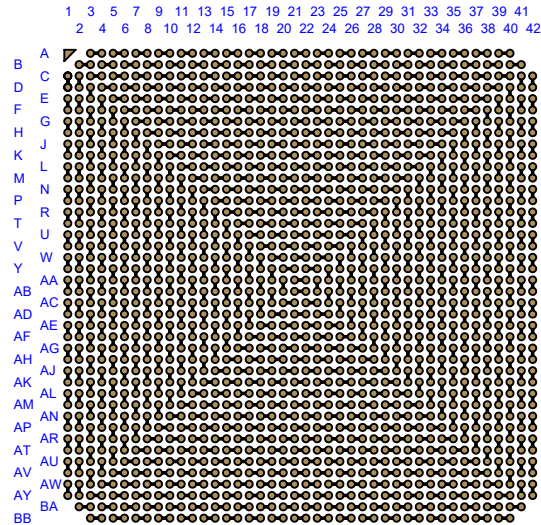

TEST VEHICLE BOARD
UNDER DEVELOPMENT

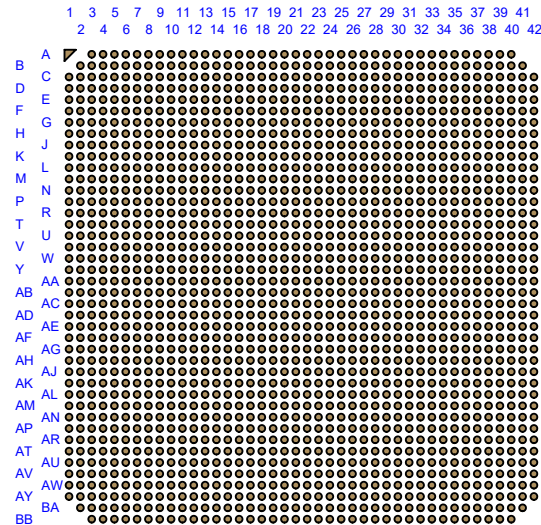

TEST VEHICLE BOARD
UNDER DEVELOPMENT

Notes: (Unless Otherwise Specified).

- 1) PCB BOARD DIMENSIONS ARE PRESENTED ONLY AS A GUIDELINE DESIGNERS SHOULD USE THEIR OWN KNOWLEDGE WHEN DESIGNING THE PCB.
- 2) PCB Cu BALL PAD DIAMETER: 0.635 [25mil].
- 3) PCB DAISY CHAIN TRACING LINE WIDTH: 0.152 [6mil].
- 4) SMD (SOLDERMASK DEFINED) PAD OPENING: 0.508mm [20mil].

TopLine®			
TITLE		SBGA1752T1.0C-DC427D DAISY CHAIN DUMMY	
SCALE	SIZE	DRAWING NO.	REV
3:2	A	514275	A
DO NOT SCALE DRAWING			SHEET 2 OF 18

BALL VIEW

42 41 40 39 38 37 36 35 34 33 32 31 30 29 28 27 26 25 24 23 22 21 20 19 18 17 16 15 14 13 12 11 10 9 8 7 6 5 4 3 2 1

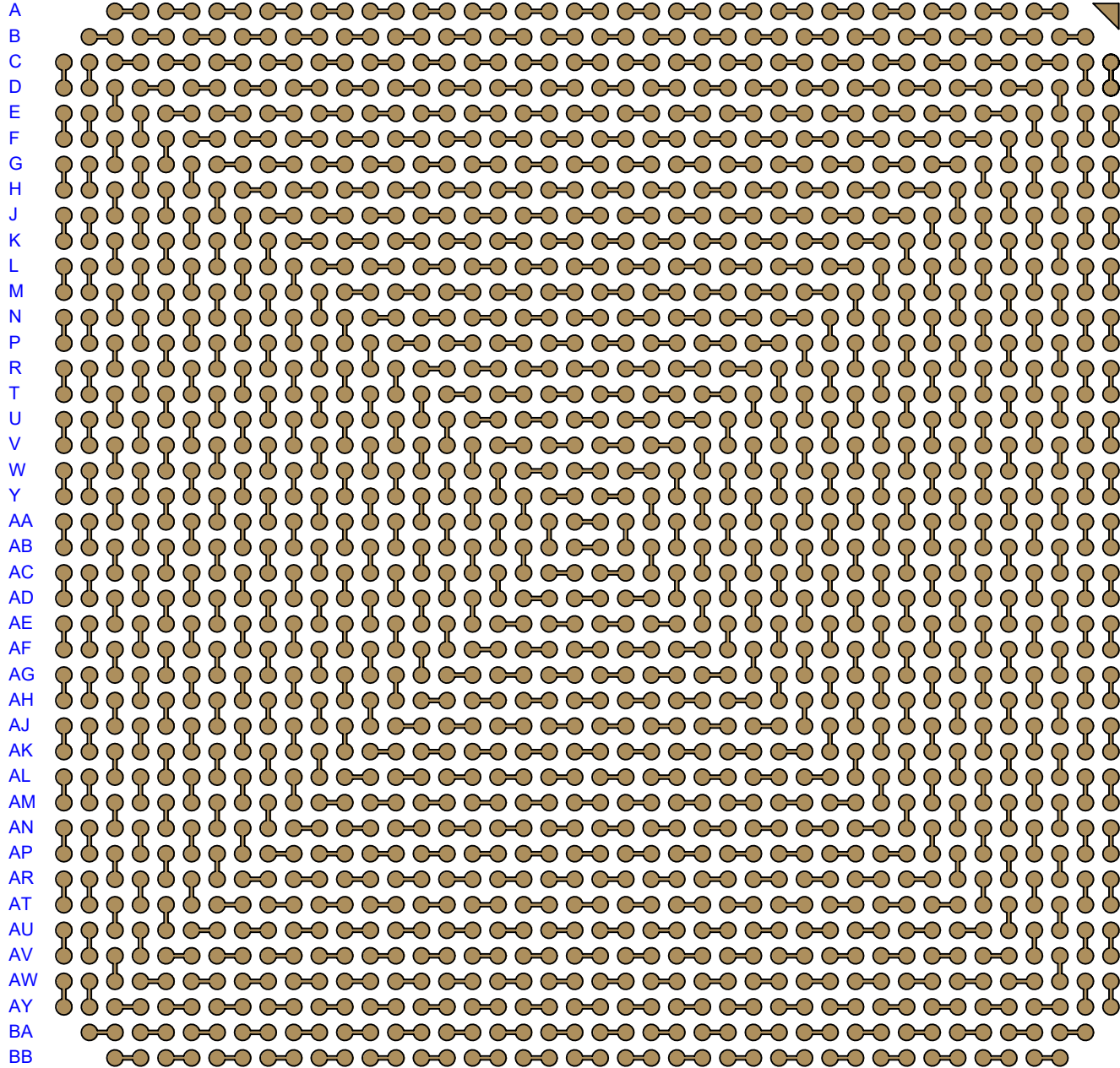

TopLine[®]			
TITLE		SBGA1752T1.0C-DC427D DAISY CHAIN DUMMY	
SCALE	SIZE	DRAWING NO.	REV
4:1	A	514275	A
DO NOT SCALE DRAWING			SHEET 3 OF 18

BOTTOM SIDE (TOP X-RAY VIEW)

1 2 3 4 5 6 7 8 9 10 11 12 13 14 15 16 17 18 19 20 21 22 23 24 25 26 27 28 29 30 31 32 33 34 35 36 37 38 39 40 41 42

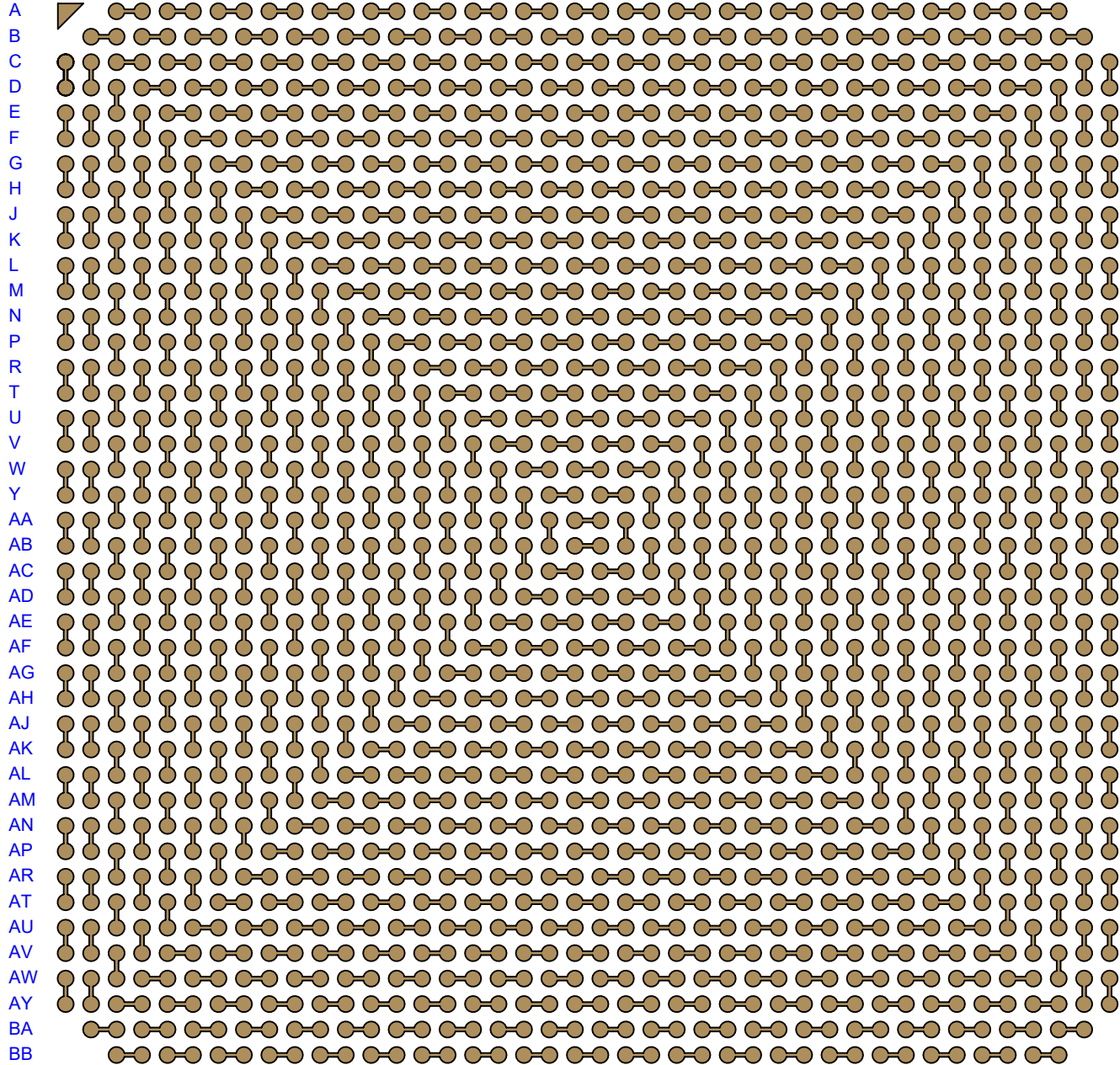

TopLine[®]

TITLE SBGA1752T1.0C-DC427D
DAISY CHAIN DUMMY

SCALE 4:1	SIZE A	DRAWING NO. 514275	REV A
--------------	-----------	-----------------------	----------

TEST VEHICLE BOARD

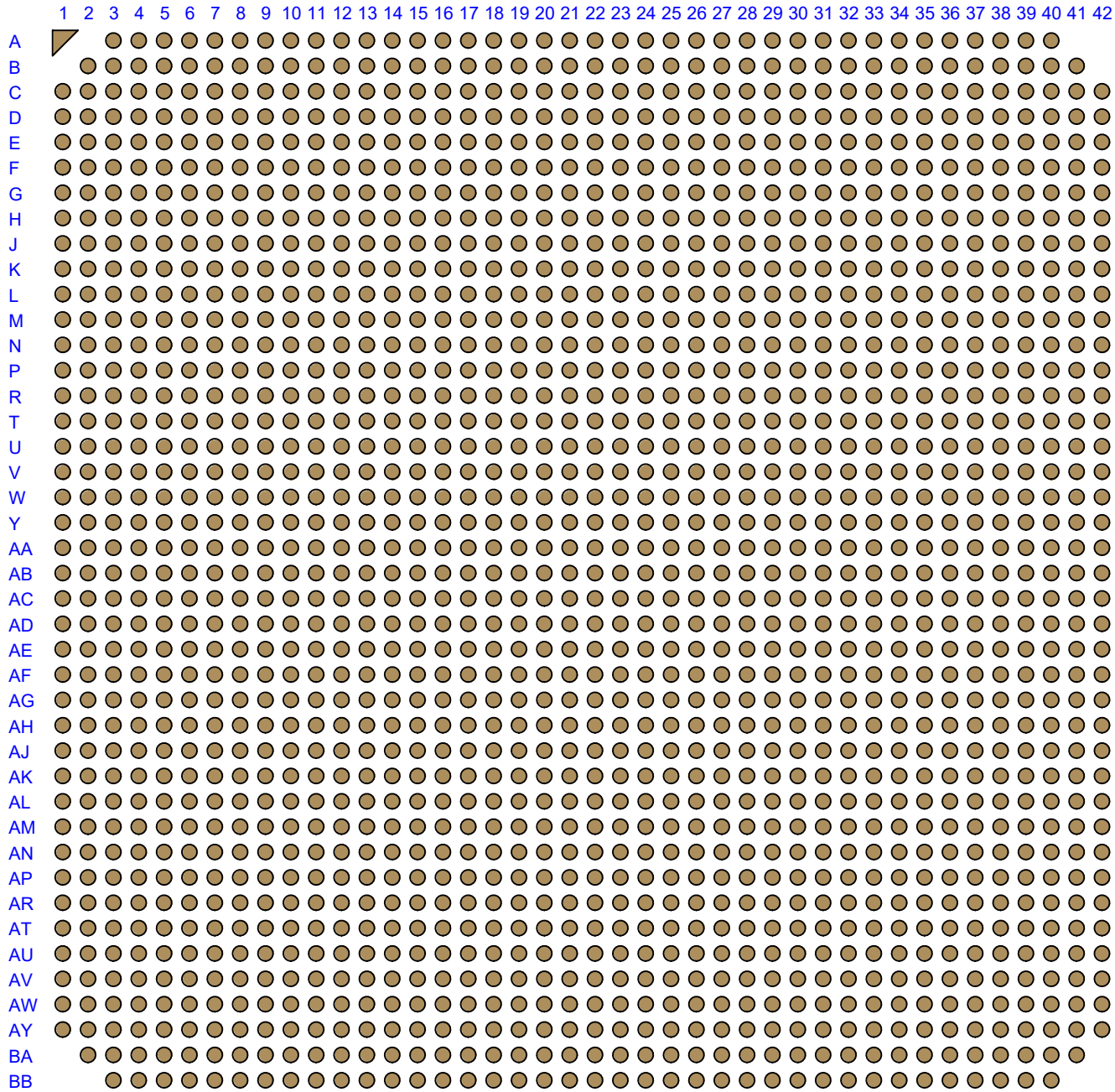

**UNDER
DEVELOPMENT**

TopLine®			
TITLE		SGBA1752T1.0C-DC427D DAISY CHAIN DUMMY	
SCALE	SIZE	DRAWING NO.	REV
4:1	A	514275	A
DO NOT SCALE DRAWING			SHEET 5 OF 18

AFTER MOUNTING TO TEST BOARD

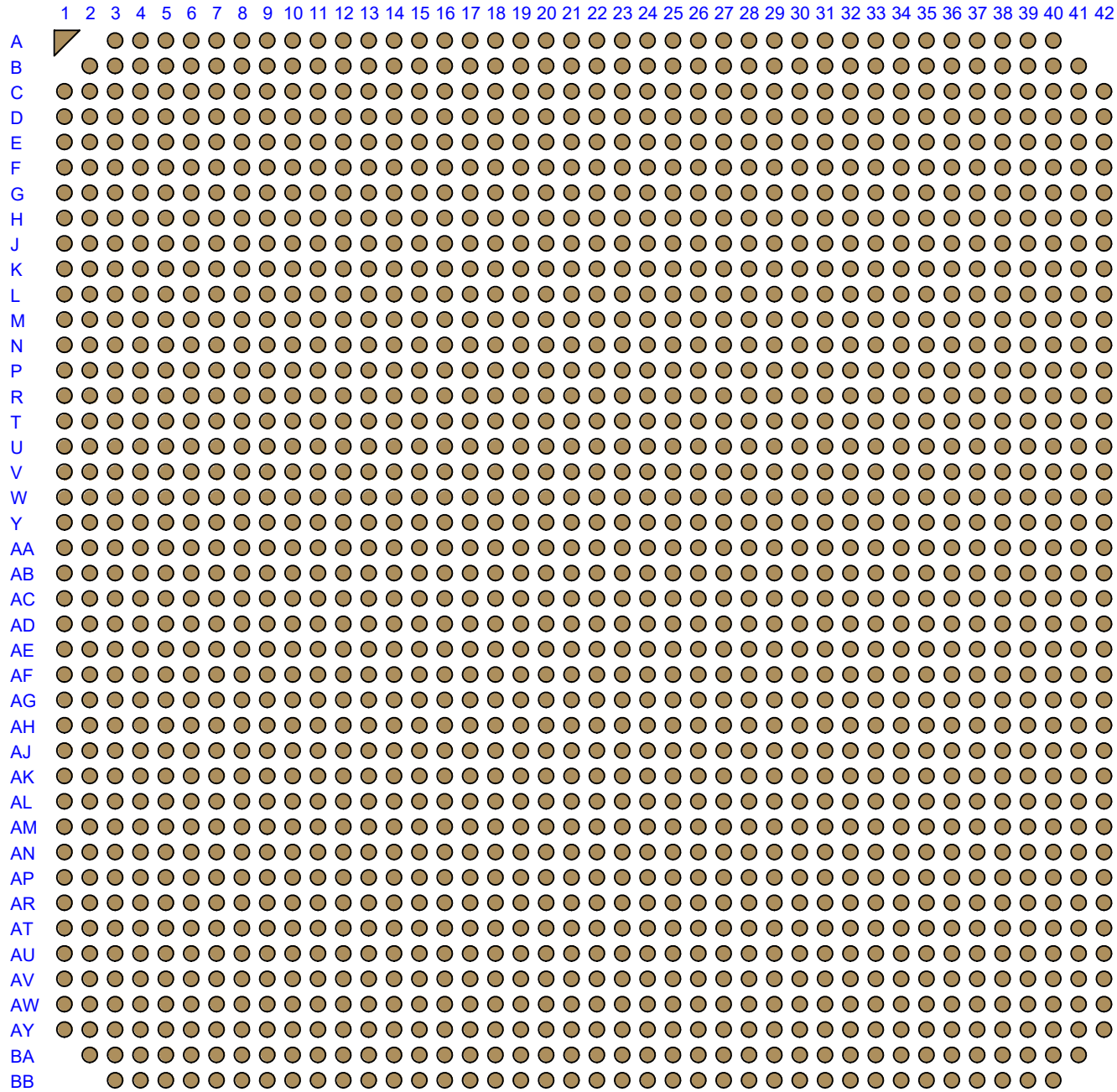

**UNDER
DEVELOPMENT**

TopLine®			
TITLE		SBGA1752T1.0C-DC427D DAISY CHAIN DUMMY	
SCALE	SIZE	DRAWING NO.	REV
4:1	A	514275	A
DO NOT SCALE DRAWING			SHEET 6 OF 18

HEAT SPREADER

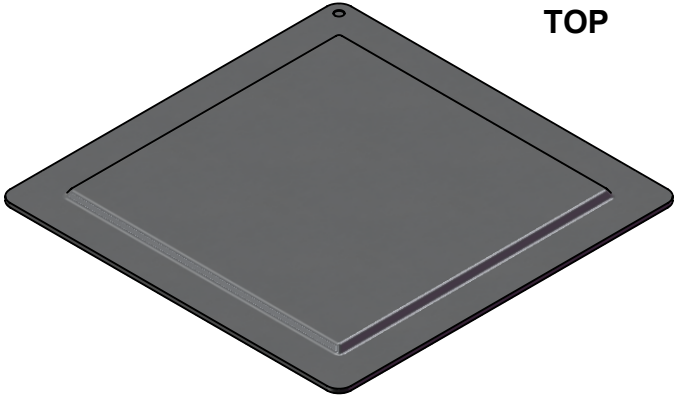
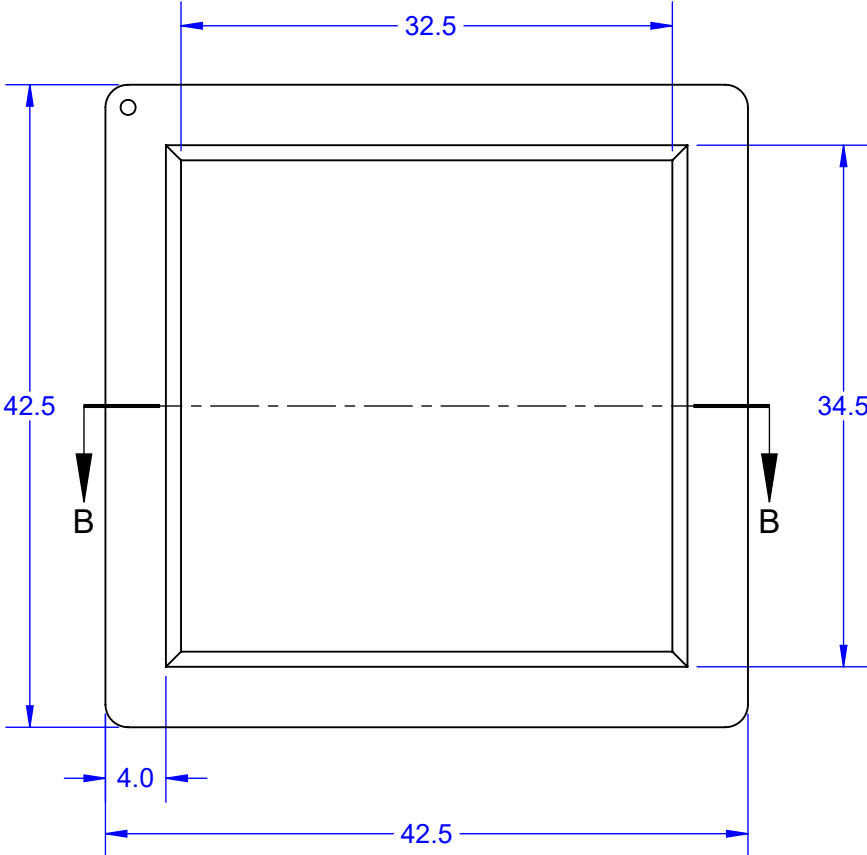

TOP

MODEL

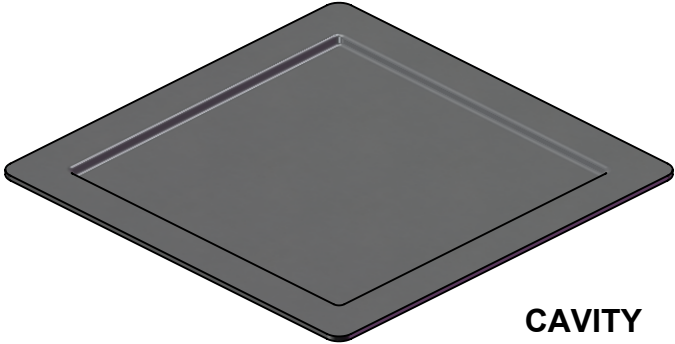

CAVITY

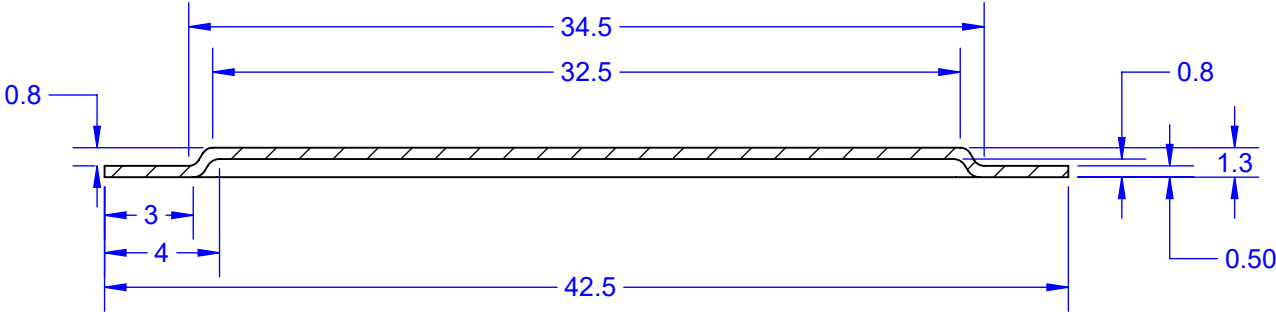

SECTION B-B
SCALE 3 : 1

TopLine®			
TITLE SBGA1752T1.0C-DC427D DAISY CHAIN DUMMY			
SCALE 2:1	SIZE A	DRAWING NO. 514275	REV A
DO NOT SCALE DRAWING			SHEET 7 OF 18

MODEL

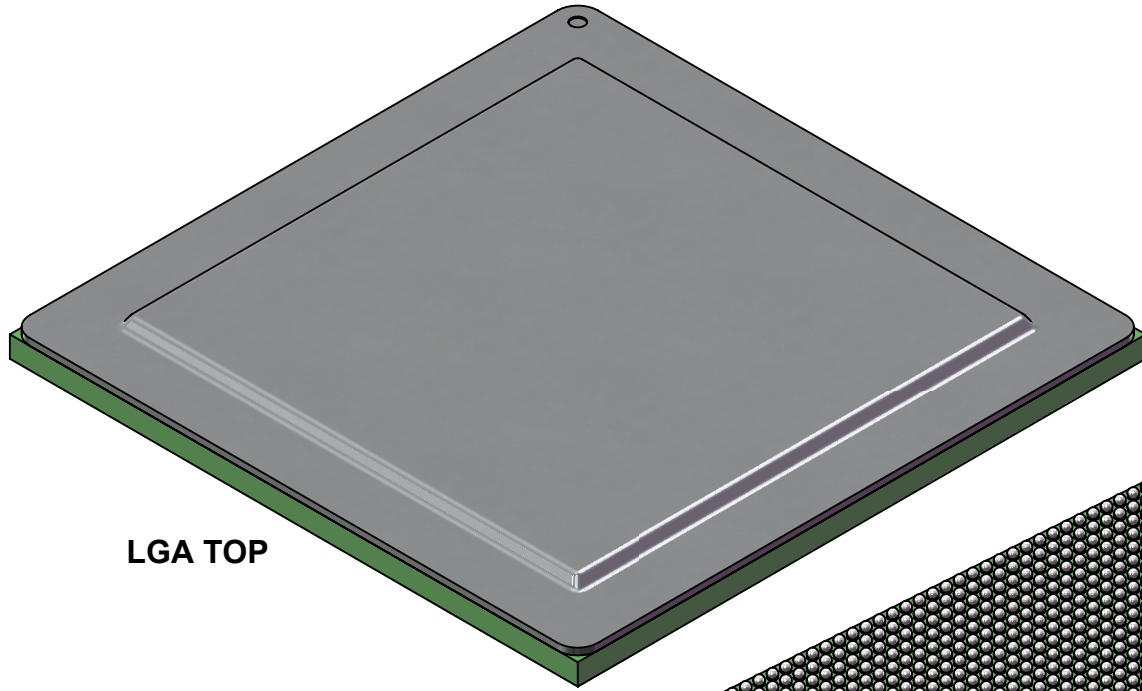

LGA TOP

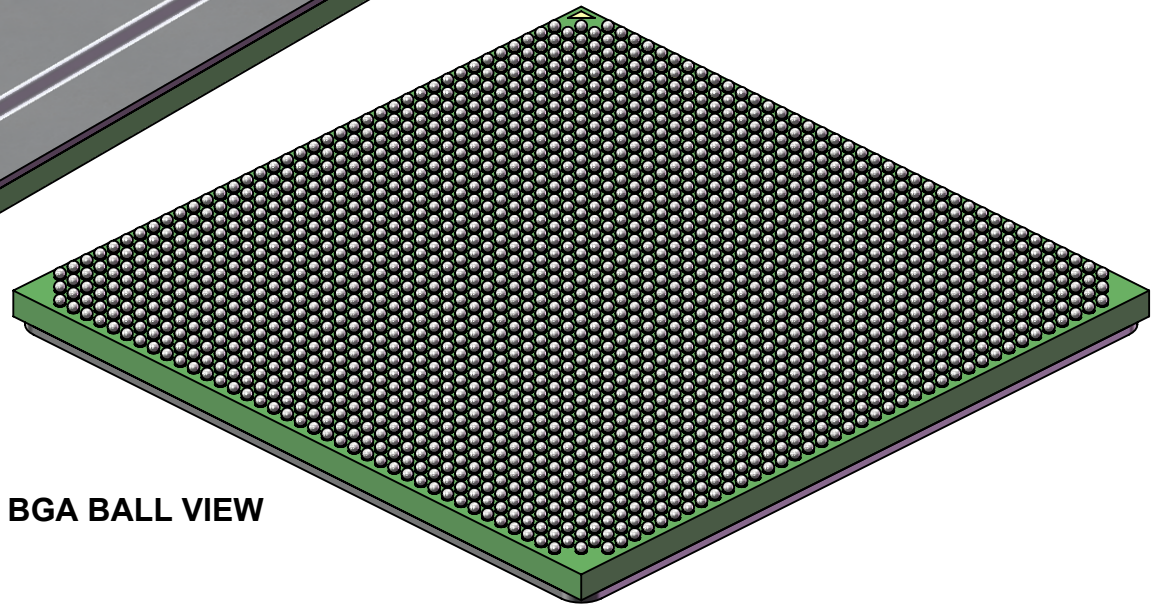

BGA BALL VIEW

TopLine[®]

TITLE SBGA1752T1.0C-DC427D
DAISY CHAIN DUMMY

SCALE 2.5:1	SIZE A	DRAWING NO. 514275	REV A
----------------	-----------	-----------------------	----------

DO NOT SCALE DRAWING

SHEET 8 OF 18

NET LIST DAISY CHAIN CONNECTION TABLE

DC PAIR	
A3	A4
A5	A6
A7	A8
A9	A10
A11	A12
A13	A14
A15	A16
A17	A18
A19	A20
A21	A22
A23	A24
A25	A26
A27	A28
A29	A30
A31	A32
A33	A34
A35	A36
A37	A38
A39	A40
B2	B3
B4	B5
B6	B7
B8	B9
B10	B11
B12	B13
B14	B15
B16	B17
B18	B19
B20	B21
B22	B23
B24	B25
B26	B27
B28	B29
B30	B31
B32	B33
B34	B35
B36	B37
B38	B39
B40	B41

DC PAIR	
C1	D1
C2	D2
C3	C4
C5	C6
C7	C8
C9	C10
C11	C12
C13	C14
C15	C16
C17	C18
C19	C20
C21	C22
C23	C24
C25	C26
C27	C28
C29	C30
C31	C32
C33	C34
C35	C36
C37	C38
C39	C40
C41	D41
C42	D42
D3	E3
D4	D5
D6	D7
D8	D9
D10	D11
D12	D13
D14	D15
D16	D17
D18	D19
D20	D21
D22	D23
D24	D25
D26	D27
D28	D29
D30	D31
D32	D33
D34	D35
D36	D37
D38	D39
D40	E40

DC PAIR	
E1	F1
E2	F2
E4	F4
E5	E6
E7	E8
E9	E10
E11	E12
E13	E14
E15	E16
E17	E18
E19	E20
E21	E22
E23	E24
E25	E26
E27	E28
E29	E30
E31	E32
E33	E34
E35	E36
E37	E38
E39	F39
E41	F41
E42	F42
F3	G3
F5	G5
F6	F7
F8	F9
F10	F11
F12	F13
F14	F15
F16	F17
F18	F19
F20	F21
F22	F23
F24	F25
F26	F27
F28	F29
F30	F31
F32	F33
F34	F35
F36	F37
F38	G38
F40	G40

DC PAIR	
G1	H1
G2	H2
G4	H4
G6	H6
G7	G8
G9	G10
G11	G12
G13	G14
G15	G16
G17	G18
G19	G20
G21	G22
G23	G24
G25	G26
G27	G28
G29	G30
G31	G32
G33	G34
G35	G36
G37	H37
G39	H39
G41	H41
G42	H42
H3	J3
H5	J5
H7	J7
H8	H9
H10	H11
H12	H13
H14	H15
H16	H17
H18	H19
H20	H21
H22	H23
H24	H25
H26	H27
H28	H29
H30	H31
H32	H33
H34	H35
H36	J36
H38	J38
H40	J40

DC PAIR	
J1	K1
J2	K2
J4	K4
J6	K6
J8	K8
J9	J10
J11	J12
J13	J14
J15	J16
J17	J18
J19	J20
J21	J22
J23	J24
J25	J26
J27	J28
J29	J30
J31	J32
J33	J34
J35	K35
J37	K37
J39	K39
J41	K41
J42	K42
K3	L3
K5	L5
K7	L7
K9	L9
K10	K11
K12	K13
K14	K15
K16	K17
K18	K19
K20	K21
K22	K23
K24	K25
K26	K27
K28	K29
K30	K31
K32	K33
K34	L34
K36	L36
K38	L38
K40	L40

DC PAIR	
L1	M1
L2	M2
L4	M4
L6	M6
L8	M8
L10	M10
L11	L12
L13	L14
L15	L16
L17	L18
L19	L20
L21	L22
L23	L24
L25	L26
L27	L28
L29	L30
L31	L32
L33	M33
L35	M35
L37	M37
L39	M39
L41	M41
L42	M42
M3	N3
M5	N5
M7	N7
M9	N9
M11	N11
M12	M13
M14	M15
M16	M17
M18	M19
M20	M21
M22	M23
M24	M25
M26	M27
M28	M29
M30	M31
M32	N32
M34	N34
M36	N36
M38	N38
M40	N40

DC PAIR	
N1	P1
N2	P2
N4	P4
N6	P6
N8	P8
N10	P10
N12	P12
N13	N14
N15	N16
N17	N18
N19	N20
N21	N22
N23	N24
N25	N26
N27	N28
N29	N30
N31	P31
N33	P33
N35	P35
N37	P37
N39	P39
N41	P41
N42	P42
P3	R3
P5	R5
P7	R7
P9	R9
P11	R11
P13	R13
P14	P15
P16	P17
P18	P19
P20	P21
P22	P23
P24	P25
P26	P27
P28	P29
P30	R30
P32	R32
P34	R34
P36	R36
P38	R38
P40	R40

CONTINUED NEXT PAGE

TopLine®			
TITLE SBGA1752T1.0C-DC427D DAISY CHAIN DUMMY			
SCALE NONE	SIZE A	DRAWING NO. 514275	REV A
DO NOT SCALE DRAWING			SHEET 9 OF 18

NET LIST DAISY CHAIN CONNECTION TABLE

DC PAIR	
R1	T1
R2	T2
R4	T4
R6	T6
R8	T8
R10	T10
R12	T12
R14	T14
R15	R16
R17	R18
R19	R20
R21	R22
R23	R24
R25	R26
R27	R28
R29	T29
R31	T31
R33	T33
R35	T35
R37	T37
R39	T39
R41	T41
R42	T42
T3	U3
T5	U5
T7	U7
T9	U9
T11	U11
T13	U13
T15	U15
T16	T17
T18	T19
T20	T21
T22	T23
T24	T25
T26	T27
T28	U28
T30	U30
T32	U32
T34	U34
T36	U36
T38	U38
T40	U40

DC PAIR	
U1	V1
U2	V2
U4	V4
U6	V6
U8	V8
U10	V10
U12	V12
U14	V14
U16	V16
U17	U18
U19	U20
U21	U22
U23	U24
U25	U26
U27	V27
U29	V29
U31	V31
U33	V33
U35	V35
U37	V37
U39	V39
U41	V41
U42	V42
V3	W3
V5	W5
V7	W7
V9	W9
V11	W11
V13	W13
V15	W15
V17	W17
V18	V19
V20	V21
V22	V23
V24	V25
V26	W26
V28	W28
V30	W30
V32	W32
V34	W34
V36	W36
V38	W38
V40	W40

DC PAIR	
W1	Y1
W2	Y2
W4	Y4
W6	Y6
W8	Y8
W10	Y10
W12	Y12
W14	Y14
W16	Y16
W18	Y18
W19	W20
W21	W22
W23	W24
W25	Y25
W27	Y27
W29	Y29
W31	Y31
W33	Y33
W35	Y35
W37	Y37
W39	Y39
W41	Y41
W42	Y42
AA3	Y3
AA5	Y5
AA7	Y7
AA9	Y9
AA11	Y11
AA13	Y13
AA15	Y15
AA17	Y17
AA19	Y19
Y20	Y21
Y22	Y23
AA24	Y24
AA26	Y26
AA28	Y28
AA30	Y30
AA32	Y32
AA34	Y34
AA36	Y36
AA38	Y38
AA40	Y40

DC PAIR	
AA1	AB1
AA2	AB2
AA4	AB4
AA6	AB6
AA8	AB8
AA10	AB10
AA12	AB12
AA14	AB14
AA16	AB16
AA18	AB18
AA20	AB20
AA23	AB23
AA25	AB25
AA27	AB27
AA29	AB29
AA31	AB31
AA33	AB33
AA35	AB35
AA37	AB37
AA39	AB39
AA41	AB41
AA42	AB42
AB3	AC3
AB5	AC5
AB7	AC7
AB9	AC9
AB11	AC11
AB13	AC13
AB15	AC15
AB17	AC17
AB19	AC19
AB21	AB22
AA21	AA22
AB24	AC24
AB26	AC26
AB28	AC28
AB30	AC30
AB32	AC32
AB34	AC34
AB36	AC36
AB38	AC38
AB40	AC40

DC PAIR	
AC1	AD1
AC2	AD2
AC4	AD4
AC6	AD6
AC8	AD8
AC10	AD10
AC12	AD12
AC14	AD14
AC16	AD16
AC18	AD18
AC20	AC21
AC22	AC23
AC25	AD25
AC27	AD27
AC29	AD29
AC31	AD31
AC33	AD33
AC35	AD35
AC37	AD37
AC39	AD39
AC41	AD41
AC42	AD42
AD3	AE3
AD5	AE5
AD7	AE7
AD9	AE9
AD11	AE11
AD13	AE13
AD15	AE15
AD17	AE17
AD19	AD20
AD21	AD22
AD23	AD24
AD26	AE26
AD28	AE28
AD30	AE30
AD32	AE32
AD34	AE34
AD36	AE36
AD38	AE38
AD40	AE40

DC PAIR	
AE1	AF1
AE2	AF2
AE4	AF4
AE6	AF6
AE8	AF8
AE10	AF10
AE12	AF12
AE14	AF14
AE16	AF16
AE18	AE19
AE20	AE21
AE22	AE23
AE24	AE25
AE27	AF27
AE29	AF29
AE31	AF31
AE33	AF33
AE35	AF35
AE37	AF37
AE39	AF39
AE41	AF41
AE42	AF42
AF3	AG3
AF5	AG5
AF7	AG7
AF9	AG9
AF11	AG11
AF13	AG13
AF15	AG15
AF17	AF18
AF19	AF20
AF21	AF22
AF23	AF24
AF25	AF26
AF28	AG28
AF30	AG30
AF32	AG32
AF34	AG34
AF36	AG36
AF38	AG38
AF40	AG40

DC PAIR	
AG1	AH1
AG2	AH2
AG4	AH4
AG6	AH6
AG8	AH8
AG10	AH10
AG12	AH12
AG14	AH14
AG16	AG17
AG18	AG19
AG20	AG21
AG22	AG23
AG24	AG25
AG26	AG27
AG29	AH29
AG31	AH31
AG33	AH33
AG35	AH35
AG37	AH37
AG39	AH39
AG41	AH41
AG42	AH42
AH3	AJ3
AH5	AJ5
AH7	AJ7
AH9	AJ9
AH11	AJ11
AH13	AJ13
AH15	AH16
AH17	AH18
AH19	AH20
AH21	AH22
AH23	AH24
AH25	AH26
AH27	AH28
AH30	AJ30
AH32	AJ32
AH34	AJ34
AH36	AJ36
AH38	AJ38
AH40	AJ40

CONTINUED NEXT PAGE

			
TITLE SBGA1752T1.0C-DC427D DAISY CHAIN DUMMY			
SCALE NONE	SIZE A	DRAWING NO. 514275	REV A
DO NOT SCALE DRAWING			SHEET 10 OF 18

NET LIST DAISY CHAIN CONNECTION TABLE

DC PAIR	
AJ1	AK1
AJ2	AK2
AJ4	AK4
AJ6	AK6
AJ8	AK8
AJ10	AK10
AJ12	AK12
AJ14	AJ15
AJ16	AJ17
AJ18	AJ19
AJ20	AJ21
AJ22	AJ23
AJ24	AJ25
AJ26	AJ27
AJ28	AJ29
AJ31	AK31
AJ33	AK33
AJ35	AK35
AJ37	AK37
AJ39	AK39
AJ41	AK41
AJ42	AK42
AK3	AL3
AK5	AL5
AK7	AL7
AK9	AL9
AK11	AL11
AK13	AK14
AK15	AK16
AK17	AK18
AK19	AK20
AK21	AK22
AK23	AK24
AK25	AK26
AK27	AK28
AK29	AK30
AK32	AL32
AK34	AL34
AK36	AL36
AK38	AL38
AK40	AL40

DC PAIR	
AL1	AM1
AL2	AM2
AL4	AM4
AL6	AM6
AL8	AM8
AL10	AM10
AL12	AL13
AL14	AL15
AL16	AL17
AL18	AL19
AL20	AL21
AL22	AL23
AL24	AL25
AL26	AL27
AL28	AL29
AL30	AL31
AL33	AM33
AL35	AM35
AL37	AM37
AL39	AM39
AL41	AM41
AL42	AM42
AM3	AN3
AM5	AN5
AM7	AN7
AM9	AN9
AM11	AM12
AM13	AM14
AM15	AM16
AM17	AM18
AM19	AM20
AM21	AM22
AM23	AM24
AM25	AM26
AM27	AM28
AM29	AM30
AM31	AM32
AM34	AN34
AM36	AN36
AM38	AN38
AM40	AN40

DC PAIR	
AN1	AP1
AN2	AP2
AN4	AP4
AN6	AP6
AN8	AP8
AN10	AN11
AN12	AN13
AN14	AN15
AN16	AN17
AN18	AN19
AN20	AN21
AN22	AN23
AN24	AN25
AN26	AN27
AN28	AN29
AN30	AN31
AN32	AN33
AN35	AP35
AN37	AP37
AN39	AP39
AN41	AP41
AN42	AP42
AP3	AR3
AP5	AR5
AP7	AR7
AP9	AP10
AP11	AP12
AP13	AP14
AP15	AP16
AP17	AP18
AP19	AP20
AP21	AP22
AP23	AP24
AP25	AP26
AP27	AP28
AP29	AP30
AP31	AP32
AP33	AP34
AP36	AR36
AP38	AR38
AP40	AR40

DC PAIR	
AR1	AT1
AR2	AT2
AR4	AT4
AR6	AT6
AR8	AR9
AR10	AR11
AR12	AR13
AR14	AR15
AR16	AR17
AR18	AR19
AR20	AR21
AR22	AR23
AR24	AR25
AR26	AR27
AR28	AR29
AR30	AR31
AR32	AR33
AR34	AR35
AR37	AT37
AR39	AT39
AR41	AT41
AR42	AT42
AT3	AU3
AT5	AU5
AT7	AT8
AT9	AT10
AT11	AT12
AT13	AT14
AT15	AT16
AT17	AT18
AT19	AT20
AT21	AT22
AT23	AT24
AT25	AT26
AT27	AT28
AT29	AT30
AT31	AT32
AT33	AT34
AT35	AT36
AT38	AU38
AT40	AU40

DC PAIR	
AU1	AV1
AU2	AV2
AU4	AV4
AU6	AU7
AU8	AU9
AU10	AU11
AU12	AU13
AU14	AU15
AU16	AU17
AU18	AU19
AU20	AU21
AU22	AU23
AU24	AU25
AU26	AU27
AU28	AU29
AU30	AU31
AU32	AU33
AU34	AU35
AU36	AU37
AU39	AV39
AU41	AV41
AU42	AV42
AV3	AW3
AV5	AV6
AV7	AV8
AV9	AV10
AV11	AV12
AV13	AV14
AV15	AV16
AV17	AV18
AV19	AV20
AV21	AV22
AV23	AV24
AV25	AV26
AV27	AV28
AV29	AV30
AV31	AV32
AV33	AV34
AV35	AV36
AV37	AV38
AV40	AW40

DC PAIR	
AW1	AY1
AW2	AY2
AW4	AW5
AW6	AW7
AW8	AW9
AW10	AW11
AW12	AW13
AW14	AW15
AW16	AW17
AW18	AW19
AW20	AW21
AW22	AW23
AW24	AW25
AW26	AW27
AW28	AW29
AW30	AW31
AW32	AW33
AW34	AW35
AW36	AW37
AW38	AW39
AW41	AY41
AW42	AY42
AY3	AY4
AY5	AY6
AY7	AY8
AY9	AY10
AY11	AY12
AY13	AY14
AY15	AY16
AY17	AY18
AY19	AY20
AY21	AY22
AY23	AY24
AY25	AY26
AY27	AY28
AY29	AY30
AY31	AY32
AY33	AY34
AY35	AY36
AY37	AY38
AY39	AY40

DC PAIR	
BA2	BA3
BA4	BA5
BA6	BA7
BA8	BA9
BA10	BA11
BA12	BA13
BA14	BA15
BA16	BA17
BA18	BA19
BA20	BA21
BA22	BA23
BA24	BA25
BA26	BA27
BA28	BA29
BA30	BA31
BA32	BA33
BA34	BA35
BA36	BA37
BA38	BA39
BA40	BA41
BB3	BB4
BB5	BB6
BB7	BB8
BB9	BB10
BB11	BB12
BB13	BB14
BB15	BB16
BB17	BB18
BB19	BB20
BB21	BB22
BB23	BB24
BB25	BB26
BB27	BB28
BB29	BB30
BB31	BB32
BB33	BB34
BB35	BB36
BB37	BB38
BB39	BB40

TopLine®			
TITLE SBGA1752T1.0C-DC427D DAISY CHAIN DUMMY			
SCALE NONE	SIZE A	DRAWING NO. 514275	REV A
DO NOT SCALE DRAWING			SHEET 11 OF 18

TOP LAYER - LAYER 1

1 2 3 4 5 6 7 8 9 10 11 12 13 14 15 16 17 18 19 20 21 22 23 24 25 26 27 28 29 30 31 32 33 34 35 36 37 38 39 40 41 42

A
B
C
D
E
F
G
H
J
K
L
M
N
P
R
T
U
V
W
Y
AA
AB
AC
AD
AE
AF
AG
AH
AJ
AK
AL
AM
AN
AP
AR
AT
AU
AV
AW
AY
BA
BB

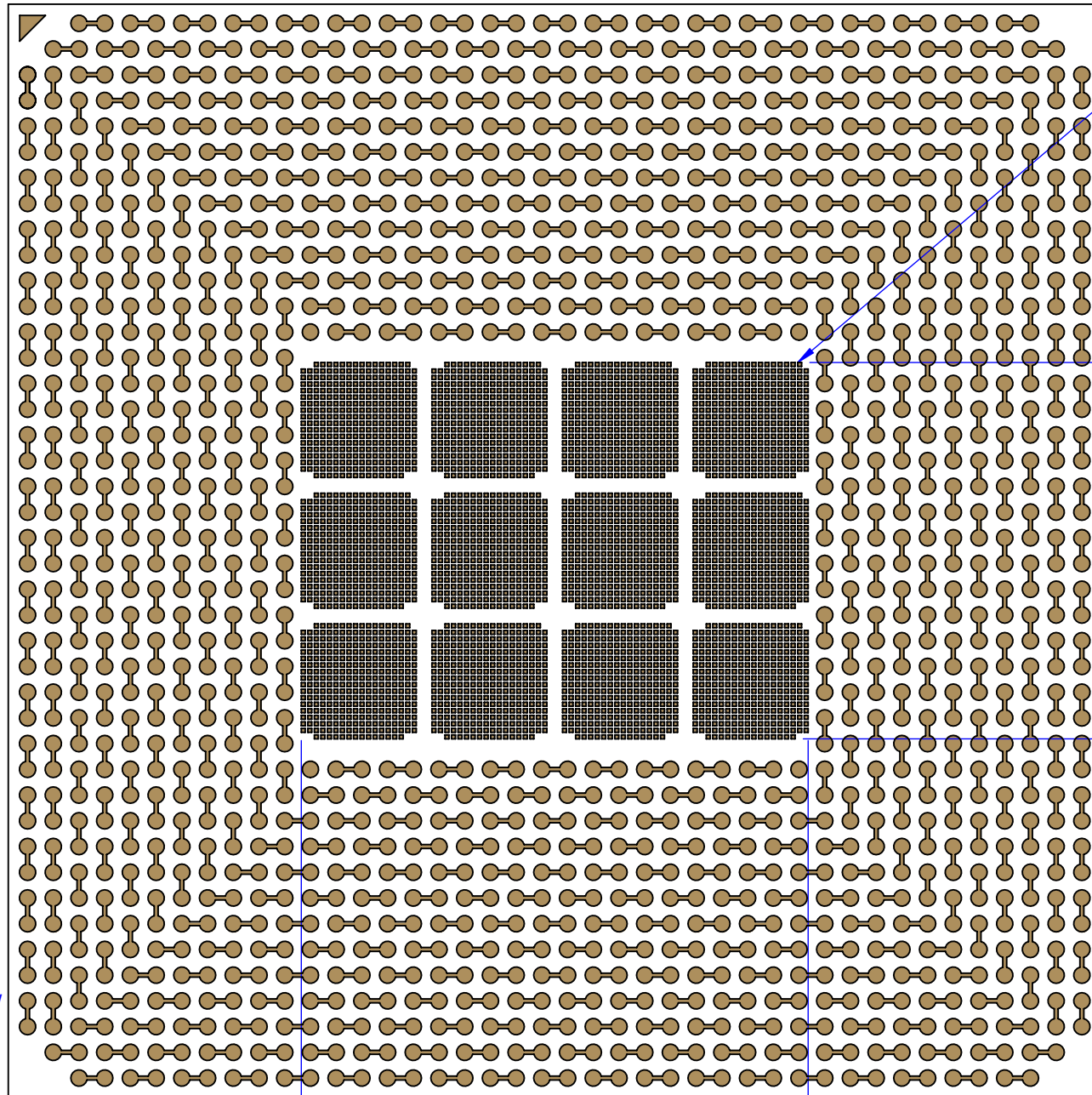

SEE DETAIL B
PAGE 18

15.42

19.56

42.5

TopLine[®]

TITLE SBGA1752T1.0C-DC427D
DAISY CHAIN DUMMY

SCALE 4:1	SIZE A	DRAWING NO. 514275	REV A
--------------	-----------	-----------------------	----------

DO NOT SCALE DRAWING SHEET 12 OF 18

SOLDER MASK TOP

1 2 3 4 5 6 7 8 9 10 11 12 13 14 15 16 17 18 19 20 21 22 23 24 25 26 27 28 29 30 31 32 33 34 35 36 37 38 39 40 41 42

A
B
C
D
E
F
G
H
J
K
L
M
N
P
R
T
U
V
W
Y
AA
AB
AC
AD
AE
AF
AG
AH
AJ
AK
AL
AM
AN
AP
AR
AT
AU
AV
AW
AY
BA
BB

MASK OPEN FIDUCIAL
4 PLACES ϕ 0.8

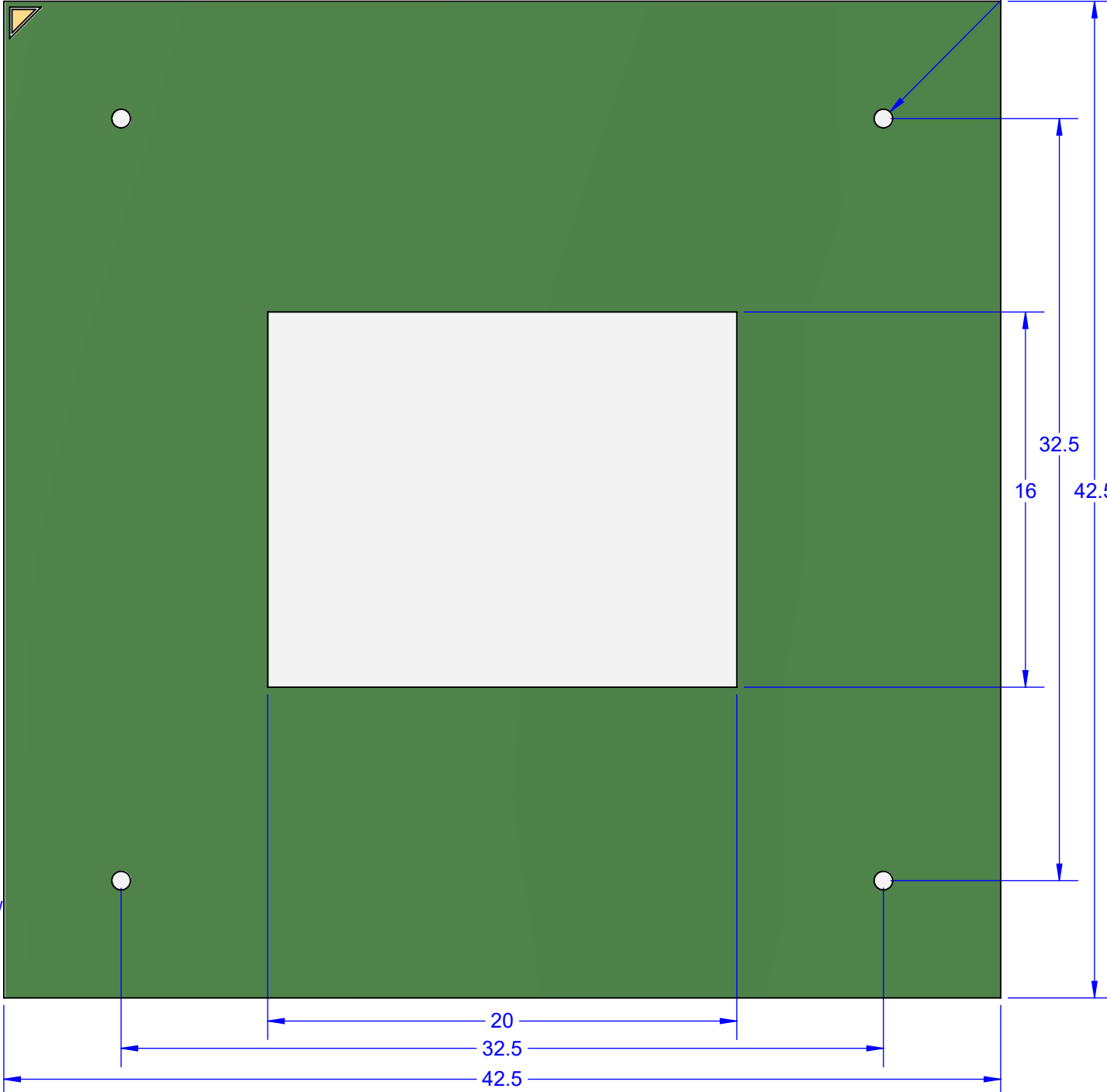

TopLine®			
TITLE SBGA1752T1.0C-DC427D DAISY CHAIN DUMMY			
SCALE 4:1	SIZE A	DRAWING NO. 514275	REV A
DO NOT SCALE DRAWING			SHEET 13 OF 18

GROUND PLANE - LAYER 2

1 2 3 4 5 6 7 8 9 10 11 12 13 14 15 16 17 18 19 20 21 22 23 24 25 26 27 28 29 30 31 32 33 34 35 36 37 38 39 40 41 42

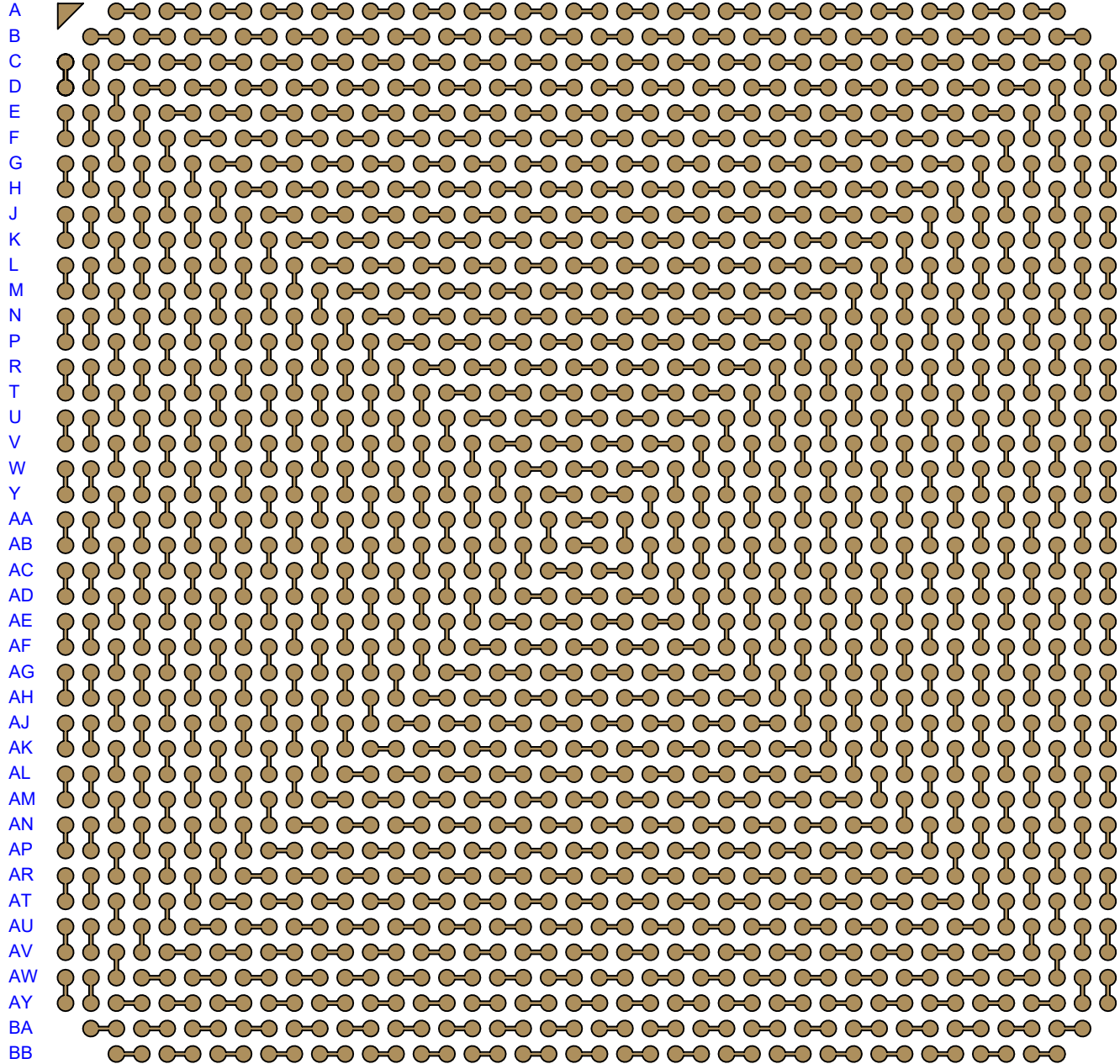

TITLE			
SbGA1752T1.0C-DC427D DAISY CHAIN DUMMY			
SCALE	SIZE	DRAWING NO.	REV
4:1	A	514275	A
DO NOT SCALE DRAWING			SHEET 14 OF 18

GROUND PLANE - LAYER 3

1 2 3 4 5 6 7 8 9 10 11 12 13 14 15 16 17 18 19 20 21 22 23 24 25 26 27 28 29 30 31 32 33 34 35 36 37 38 39 40 41 42

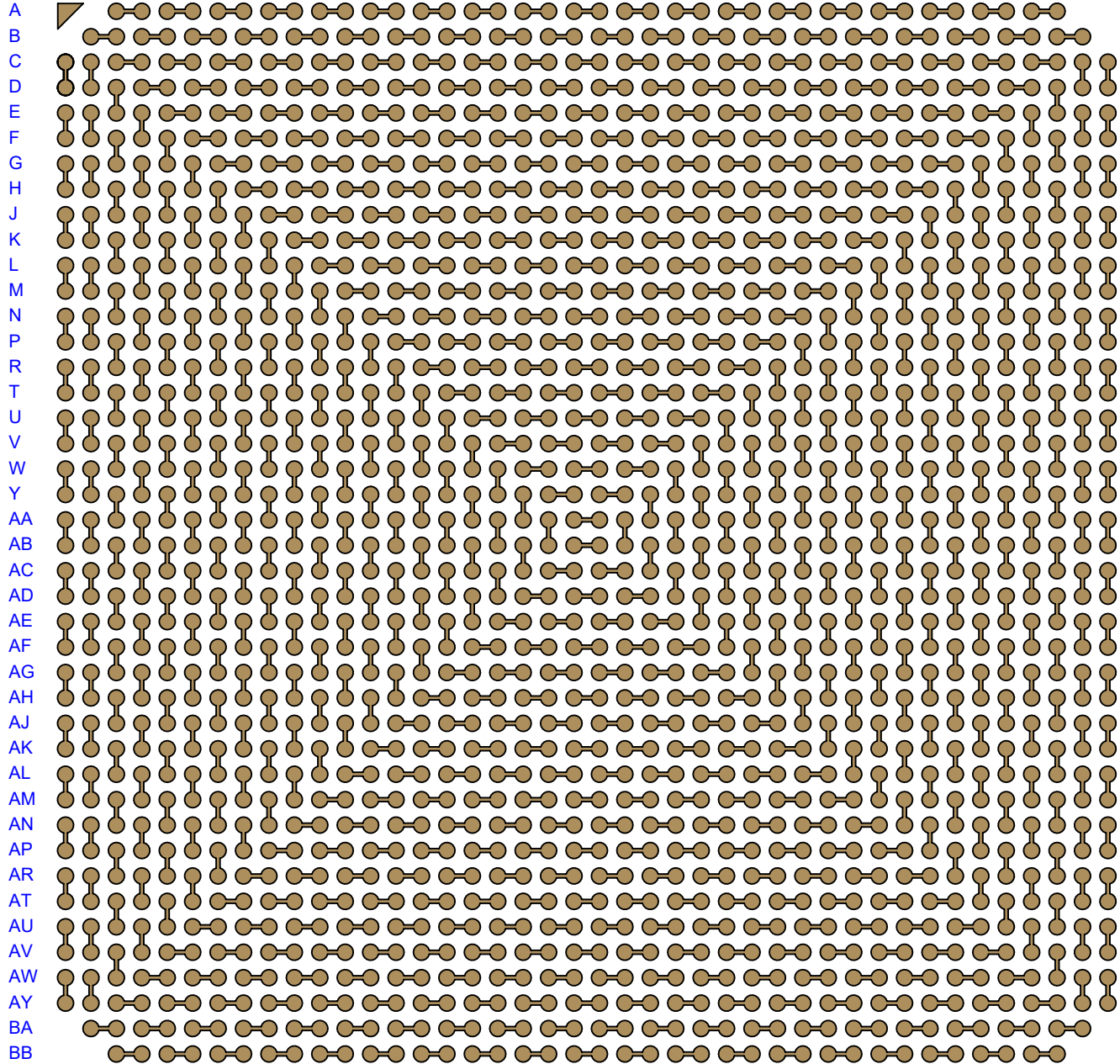

TITLE			
SbGA1752T1.0C-DC427D DAISY CHAIN DUMMY			
SCALE	SIZE	DRAWING NO.	REV
4:1	A	514275	A
DO NOT SCALE DRAWING			SHEET 15 OF 18

BOTTOM SIDE (TOP X-RAY VIEW) - LAYER 4

1 2 3 4 5 6 7 8 9 10 11 12 13 14 15 16 17 18 19 20 21 22 23 24 25 26 27 28 29 30 31 32 33 34 35 36 37 38 39 40 41 42

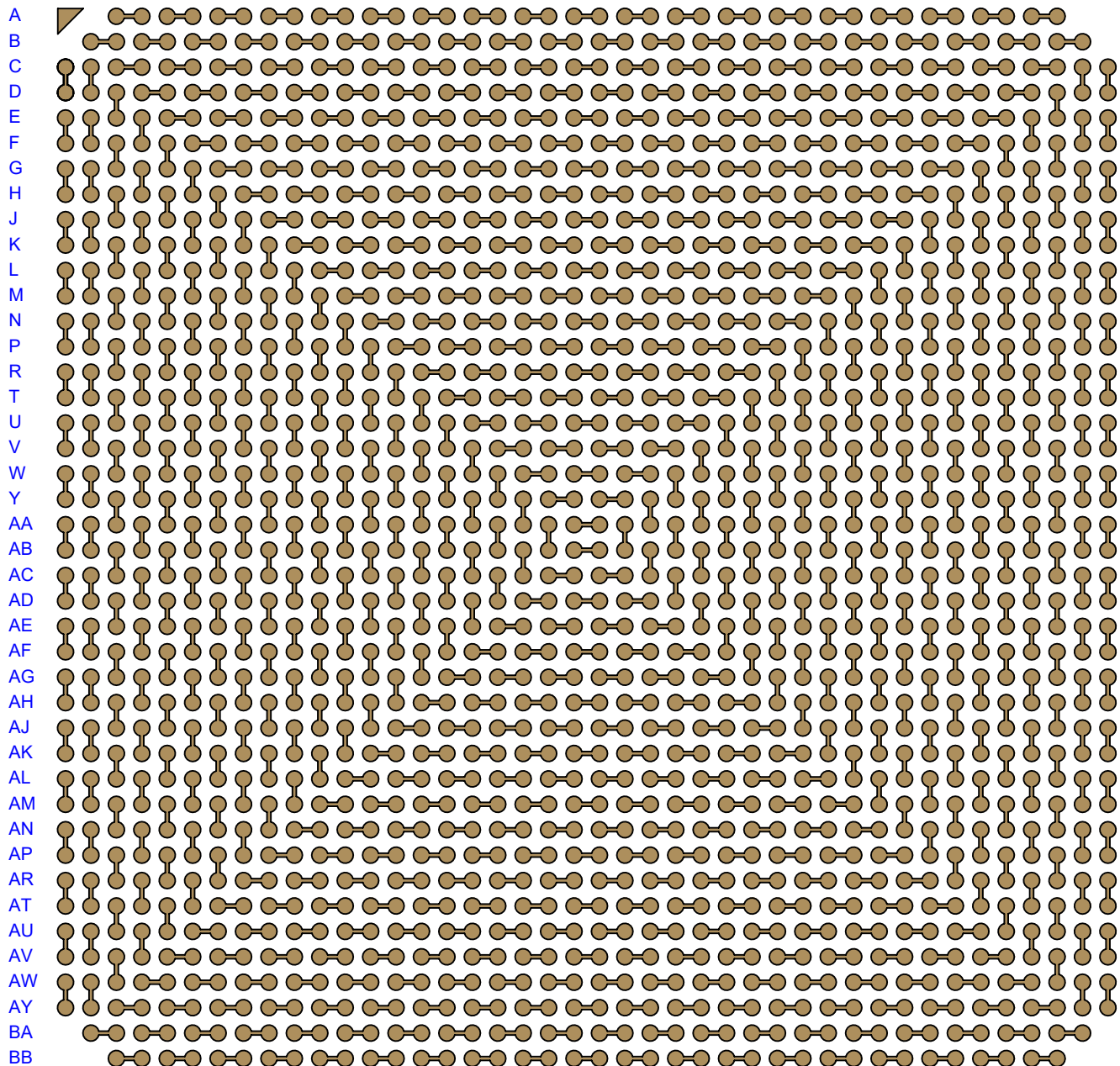

TITLE			
SbGA1752T1.0C-DC427D DAISY CHAIN DUMMY			
SCALE	SIZE	DRAWING NO.	REV
4:1	A	514275	A
DO NOT SCALE DRAWING			SHEET 16 OF 18

BOTTOM SOLDER MASK (RIGHT READING)

42 41 40 39 38 37 36 35 34 33 32 31 30 29 28 27 26 25 24 23 22 21 20 19 18 17 16 15 14 13 12 11 10 9 8 7 6 5 4 3 2 1

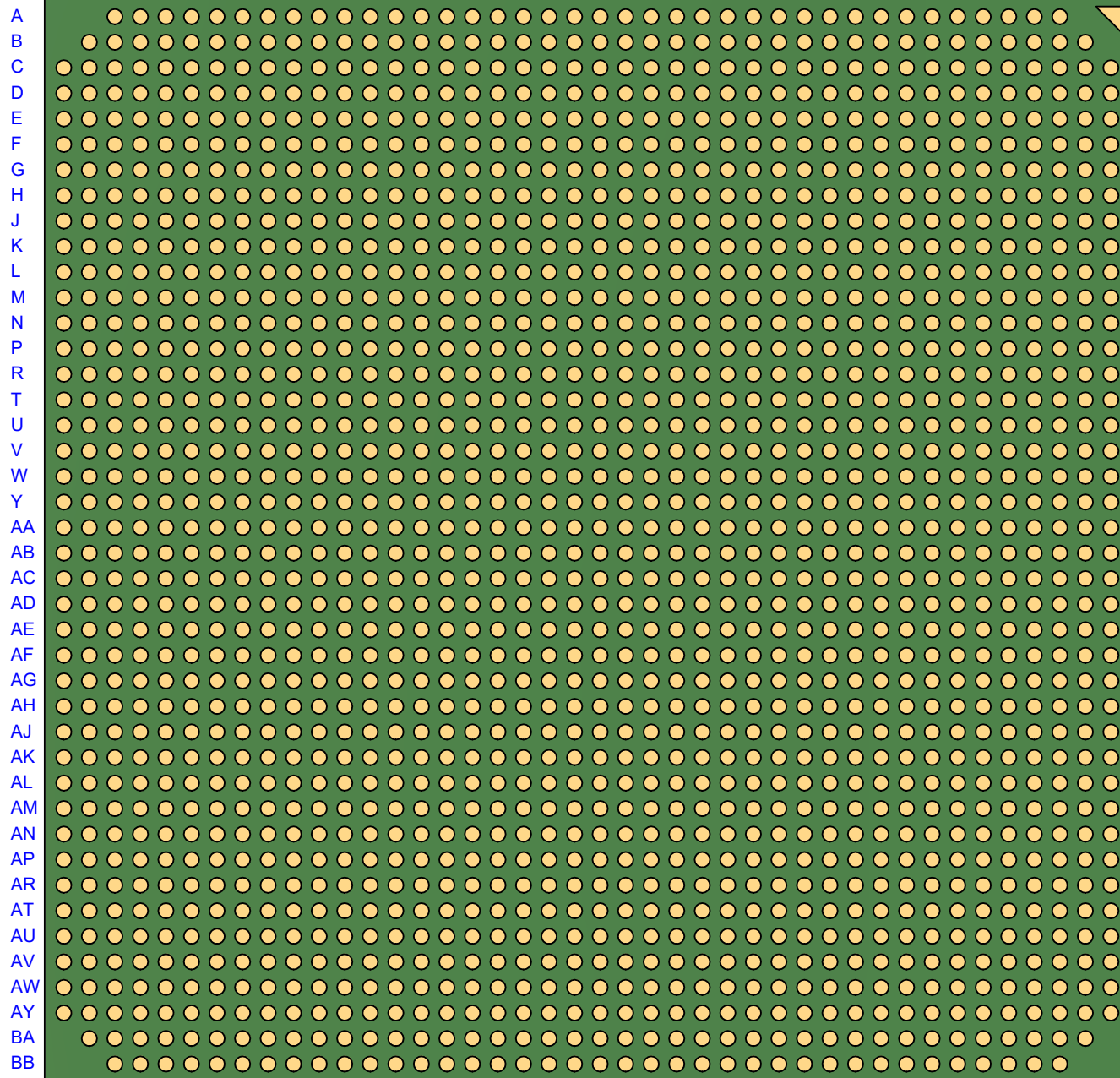

TopLine[®]

TITLE SBGA1752T1.0C-DC427D
DAISY CHAIN DUMMY

SCALE 4:1	SIZE A	DRAWING NO. 514275	REV A
--------------	-----------	-----------------------	----------

DO NOT SCALE DRAWING SHEET 17 OF 18

DETAIL B PCB DIE PADS (TOP) Micron (µm)

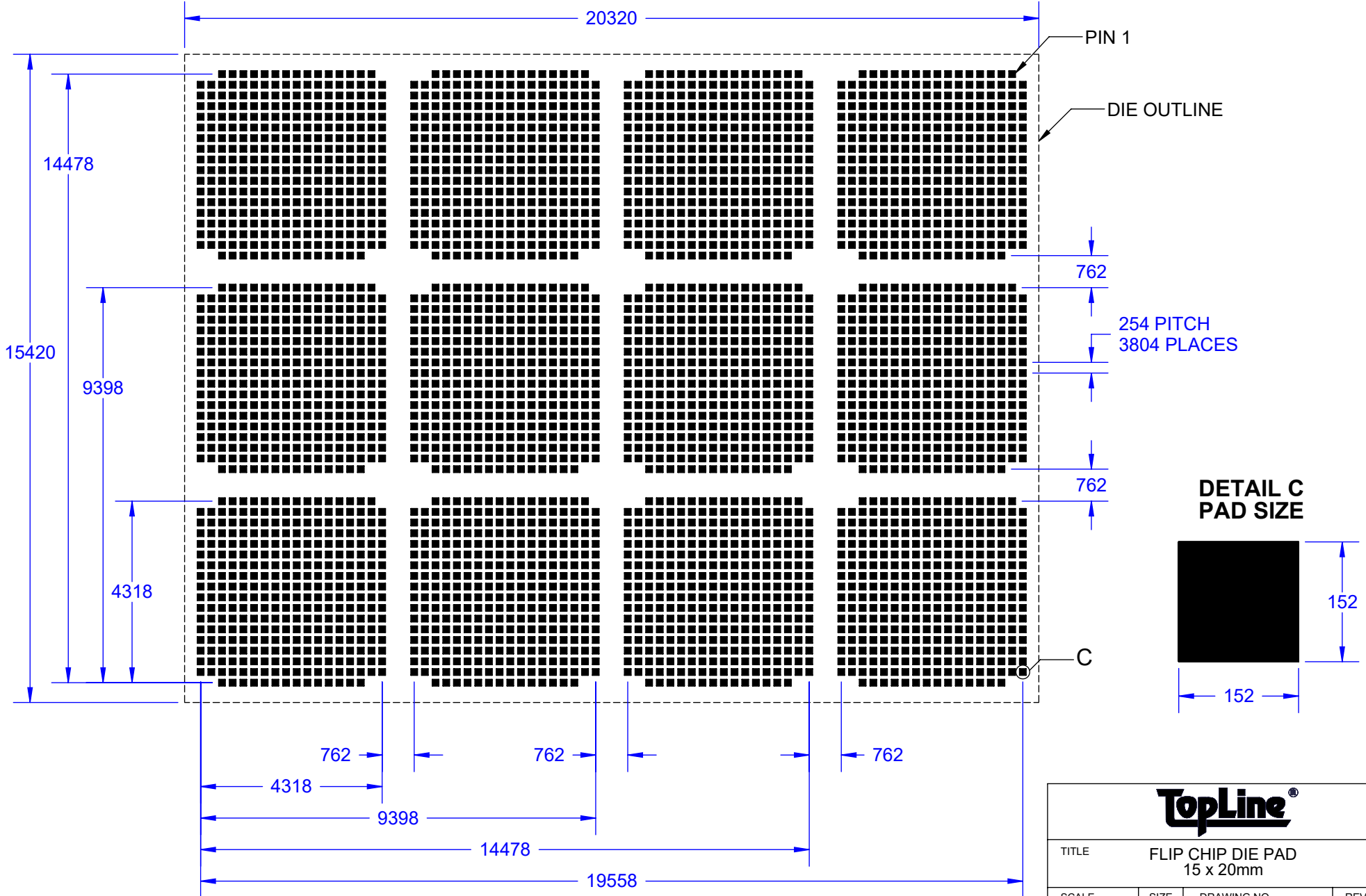

TopLine®			
TITLE FLIP CHIP DIE PAD 15 x 20mm			
SCALE 8:1	SIZE A	DRAWING NO. 514275	REV A
DO NOT SCALE DRAWING			SHEET 18 OF 18